

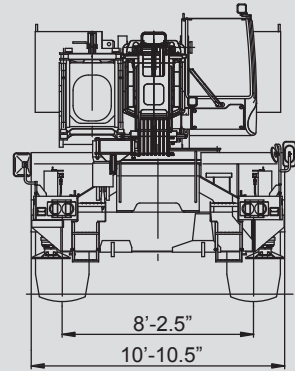

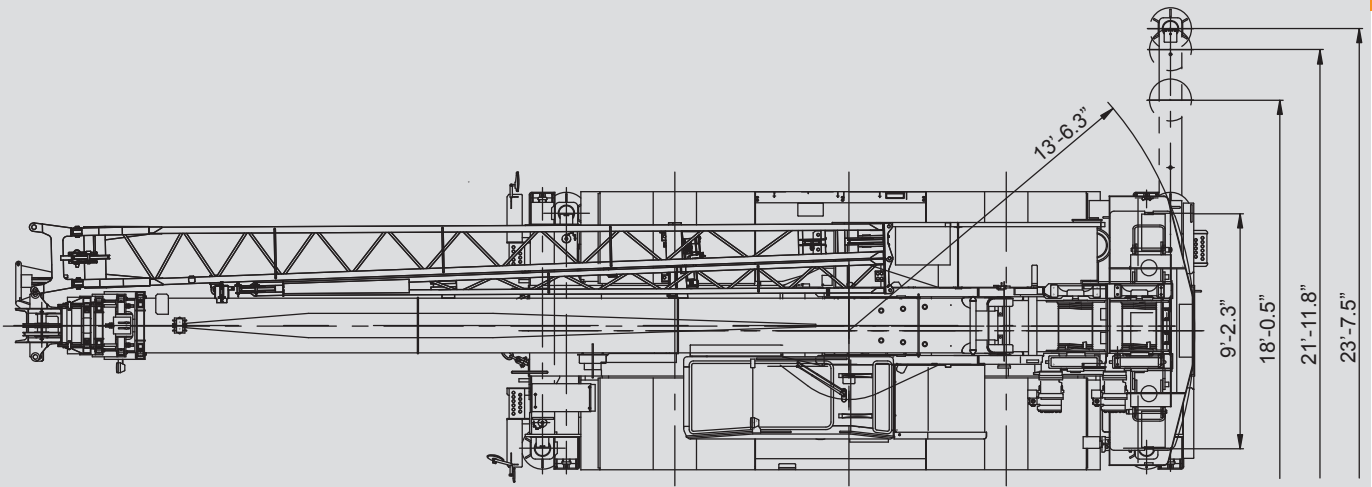

80 t Rough Terrain Crane

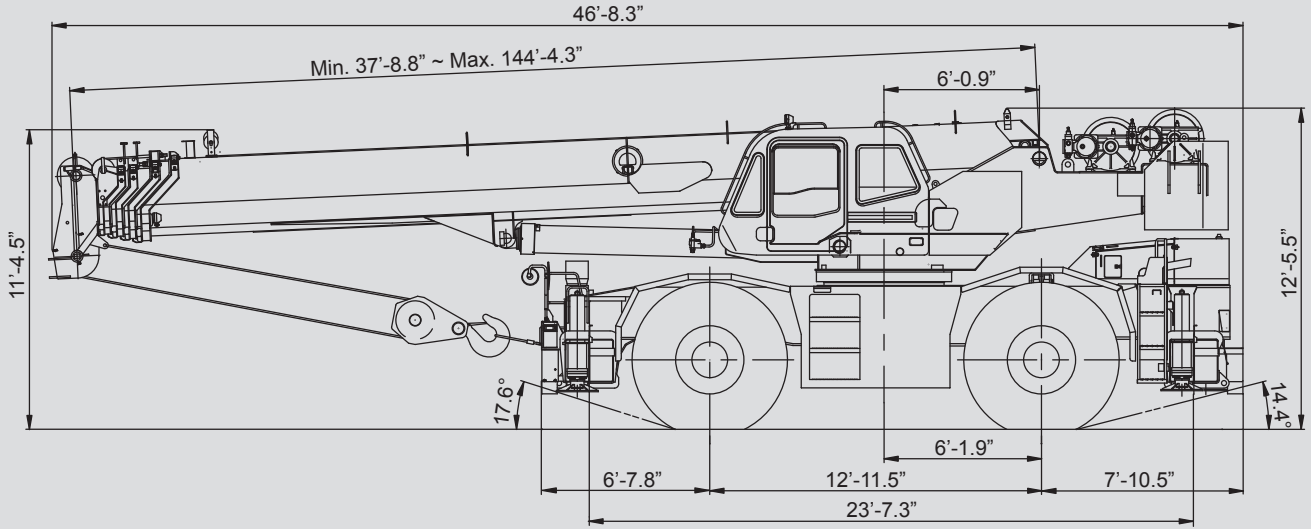
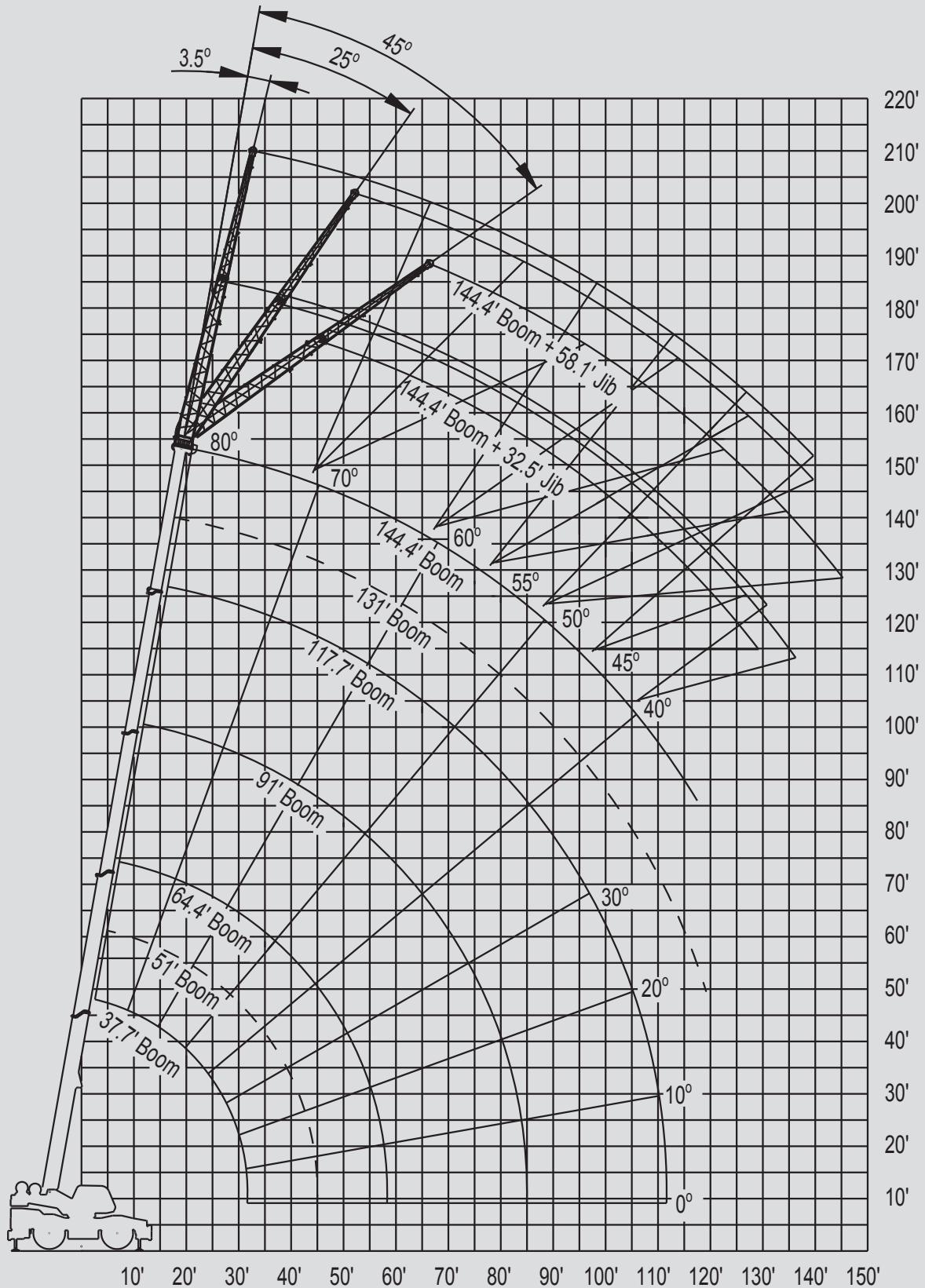

Carry Decks
 Boom Trucks
 Rough Terrain Cranes
 All Terrain Cranes
 Truck Cranes
 Crawler Cranes
 Access Platforms
 Fork Lifts

Working range



|     | | | | | | | | | | | |
|---|-----------------|-----------|------|------|------|------|-------|------|-------------|------------------|-----|
| 37.7-144.4 ft | | | | | | | | | | | |
| fix | | | | | | | | | | | |
| 23'7.3"x23'7.5" | | | | | | | | | | | |
| 100% | | | | | | | | | | | |
| 360° | | | | | | | | | | | |
| ft | 37.7 I, II * | 51 I * | 64.4 | | 91 | | 117.7 | | 131 II * | 144.4 I, II * | ft |
| | I * | II * | I * | II * | I * | II * | I * | II * | II * | I, II * | |
| 10 | 160 | 103.6 | 88.1 | 44 | | | | | | | 10 |
| 12 | 125 | 103.6 | 88.1 | 44 | | | | | | | 12 |
| 15 | 108 | 103.6 | 88.1 | 44 | 44 | 30.8 | | | | | 15 |
| 20 | 78.4 | 77.8 | 71.9 | 44 | 44 | 30.8 | 30.8 | 17.6 | | | 20 |
| 25 | 59.4 | 59 | 56.1 | 44 | 44 | 30.8 | 30.8 | 17.6 | 17.6 | 17.6 | 25 |
| 30 | 45.9 | 44.6 | 42.6 | 44 | 39 | 26.7 | 30.8 | 17.6 | 17.6 | 17.6 | 30 |
| 35 | | 33.8 | 33 | 39.9 | 34 | 23.2 | 28.2 | 17.6 | 17.6 | 17.6 | 35 |
| 40 | | 26.3 | 25.5 | 32.3 | 28.7 | 20.4 | 24.7 | 17.6 | 17.6 | 17.6 | 40 |
| 45 | | 20.9 | 20 | 26.4 | 23.6 | 18.2 | 21.8 | 16.4 | 17.6 | 17.6 | 45 |
| 50 | | | 15.9 | 21.9 | 19.3 | 16.4 | 19.5 | 14.7 | 16.2 | 17.1 | 50 |
| 60 | | | | | 13.2 | 14.5 | 14.8 | 11.9 | 13.3 | 13.9 | 60 |
| 70 | | | | | 9 | 11.4 | 10.7 | 9.9 | 11.1 | 10.9 | 70 |
| 80 | | | | | 6.1 | 9.5 | 7.6 | 8.4 | 9 | 8.2 | 80 |
| 90 | | | | | | | 5.3 | 7.2 | 6.9 | 6.1 | 90 |
| 100 | | | | | | | 3.5 | 5.9 | 5.1 | 4.3 | 100 |
| 110 | | | | | | | 2.1 | 4.6 | 3.6 | 2.9 | 110 |
| 120 | | | | | | | | | 2.6 | 1.8 | 120 |

* Telescoping mode

Carry Decks

Boom Trucks

Rough Terrain Cranes

All Terrain Cranes

Truck Cranes

Crawler Cranes

Access Platforms

Fork Lifts

Call us (888) 972-7263



80 t | Rough Terrain Crane

| | | | | |
|---------|--------------|-----|-------------------------|------|
| | | | | |
| 144.4ft | 32.5/58.1 ft | fix | 23'7.3"x23'7.5" 100% | 360° |

| ° | ft | 32.5 3.5° | ft | 32.5 25° | ft | 32.5 45° | ft | 58.1 3.5° | ft | 58.1 25° | ft | 58.1 45° | ° |
|----|------|--------------|------|-------------|------|-------------|------|--------------|------|-------------|------|-------------|----|
| 80 | 32.7 | 9.9 | 44.5 | 8.8 | 52.7 | 8.1 | 40.6 | 5.9 | 64.3 | 5.4 | 73.5 | 3.4 | 80 |
| 75 | 50.3 | 9.9 | 61.2 | 8.7 | 67.6 | 7.3 | 60.6 | 5.9 | 82.5 | 4.8 | 89.9 | 3.4 | 75 |
| 70 | 66.4 | 9.7 | 75.9 | 7.6 | 81.2 | 6.6 | 79.3 | 5.9 | 98.7 | 4.2 | 105 | 3.4 | 70 |
| 65 | 80.5 | 7.9 | 89.3 | 6.6 | 93.9 | 6 | 95.6 | 4.9 | 114 | 3.7 | 118 | 3.1 | 65 |
| 60 | 93.7 | 6.3 | 102 | 5.7 | 106 | 5.4 | 111 | 4.1 | 126 | 3.3 | 131 | 2.9 | 60 |
| 55 | 106 | 5.1 | 113 | 4.5 | 116 | 4.3 | 124 | 3.1 | 141 | 2.9 | 142 | 2.7 | 55 |
| 50 | 117 | 3.5 | 124 | 3.1 | 125 | 3 | 137 | 2.1 | 151 | 1.8 | 152 | 1.7 | 50 |
| 45 | 127 | 2.2 | 133 | 2 | 134 | 2 | 149 | 1.2 | | | | | 45 |
| 40 | 137 | 1.3 | 142 | 1.2 | | | | | | | | | 40 |